

FEATURES

- Members of the Texas Instruments Widebus™ Family
- State-of-the-Art Advanced BiCMOS Technology (ABT) Design for 3.3-V Operation and Low Static-Power Dissipation
- Support Mixed-Mode Signal Operation (5-V Input and Output Voltages With 3.3-V V_{CC})
- Support Unregulated Battery Operation Down to 2.7 V
- Typical V_{OLP} (Output Ground Bounce) <0.8 V at $V_{CC} = 3.3$ V, $T_A = 25^\circ\text{C}$
- I_{off} and Power-Up 3-State Support Hot Insertion
- Bus Hold on Data Inputs Eliminates the Need for External Pullup/Pulldown Resistors
- Distributed V_{CC} and GND Pins Minimize High-Speed Switching Noise
- Flow-Through Architecture Optimizes PCB Layout
- Latch-Up Performance Exceeds 500 mA Per JESD 17
- ESD Protection Exceeds JESD 22
 - 2000-V Human-Body Model (A114-A)
 - 200-V Machine Model (A115-A)

SN54LVTH16374 . . . WD PACKAGE
SN74LVTH16374 . . . DGG OR DL PACKAGE
(TOP VIEW)

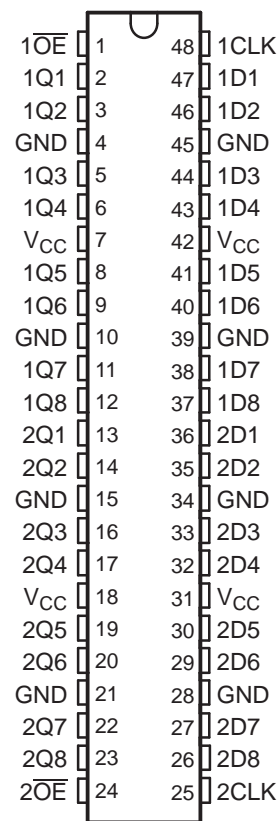

DESCRIPTION/ORDERING INFORMATION

The 'LVTH16374 devices are 16-bit edge-triggered D-type flip-flops with 3-state outputs designed for low-voltage (3.3-V) V_{CC} operation, but with the capability to provide a TTL interface to a 5-V system environment. These devices are particularly suitable for implementing buffer registers, I/O ports, bidirectional bus drivers, and working registers.

These devices can be used as two 8-bit flip-flops or one 16-bit flip-flop. On the positive transition of the clock (CLK), the Q outputs of the flip-flop take on the logic levels set up at the data (D) inputs.

A buffered output-enable (\overline{OE}) input can be used to place the eight outputs in either a normal logic state (high or low logic levels) or a high-impedance state. In the high-impedance state, the outputs neither load nor drive the bus lines significantly. The high-impedance state and the increased drive provide the capability to drive bus lines without need for interface or pullup components.

\overline{OE} does not affect internal operations of the flip-flop. Old data can be retained or new data can be entered while the outputs are in the high-impedance state.

Active bus-hold circuitry holds unused or undriven inputs at a valid logic state. Use of pullup or pulldown resistors with the bus-hold circuitry is not recommended.



Please be aware that an important notice concerning availability, standard warranty, and use in critical applications of Texas Instruments semiconductor products and disclaimers thereto appears at the end of this data sheet.

Widebus is a trademark of Texas Instruments.

SN54LVTH16374, SN74LVTH16374

3.3-V ABT 16-BIT EDGE-TRIGGERED D-TYPE FLIP-FLOPS WITH 3-STATE OUTPUTS

SCBS145Q–MAY 1992–REVISED DECEMBER 2006

DESCRIPTION/ORDERING INFORMATION (CONTINUED)

When V_{CC} is between 0 and 1.5 V, the devices are in the high-impedance state during power up or power down. However, to ensure the high-impedance state above 1.5 V, \overline{OE} should be tied to V_{CC} through a pullup resistor; the minimum value of the resistor is determined by the current-sinking capability of the driver.

These devices are fully specified for hot-insertion applications using I_{off} and power-up 3-state. The I_{off} circuitry disables the outputs, preventing damaging current backflow through the devices when they are powered down. The power-up 3-state circuitry places the outputs in the high-impedance state during power up and power down, which prevents driver conflict.

ORDERING INFORMATION

T_A	PACKAGE ⁽¹⁾		ORDERABLE PART NUMBER	TOP-SIDE MARKING
–40°C to 85°C	FBGA – GRD	Reel of 1000	SN74LVTH16374GRDR	LL374
	FBGA – ZRD (Pb-free)		SN74LVTH16374ZRDR	
	SSOP – DL	Tube of 25	SN74LVTH16374DL	LVTH16374
			74LVTH16374DLG4	
		Reel of 1000	SN74LVTH16374DLR	
			74LVTH16374DLRG4	
	TSSOP – DGG	Reel of 2000	SN74LVTH16374DGGR	LVTH16374
			74LVTH16374DGGRG4	
–55°C to 125°C	VFBGA – GQL	Reel of 1000	SN74LVTH16374KR	LL374
	VFBGA – ZQL (Pb-free)		SN74LVTH16374ZQLR	
	CFP – WD	Tube	SNJ54LVTH16374WD	SNJ54LVTH16374WD

(1) Package drawings, standard packing quantities, thermal data, symbolization, and PCB design guidelines are available at www.ti.com/sc/package.

**GQL OR ZQL PACKAGE
(TOP VIEW)**

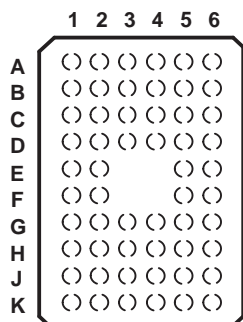

**TERMINAL ASSIGNMENTS⁽¹⁾
(56-Ball GQL/ZQL Package)**

	1	2	3	4	5	6
A	1 \overline{OE}	NC	NC	NC	NC	1CLK
B	1Q2	1Q1	GND	GND	1D1	1D2
C	1Q4	1Q3	V _{CC}	V _{CC}	1D3	1D4
D	1Q6	1Q5	GND	GND	1D5	1D6
E	1Q8	1Q7			1D7	1D8
F	2Q1	2Q2			2D2	2D1
G	2Q3	2Q4	GND	GND	2D4	2D3
H	2Q5	2Q6	V _{CC}	V _{CC}	2D6	2D5
J	2Q7	2Q8	GND	GND	2D8	2D7
K	2 \overline{OE}	NC	NC	NC	NC	2CLK

(1) NC – No internal connection

**GRD OR ZRD PACKAGE
(TOP VIEW)**

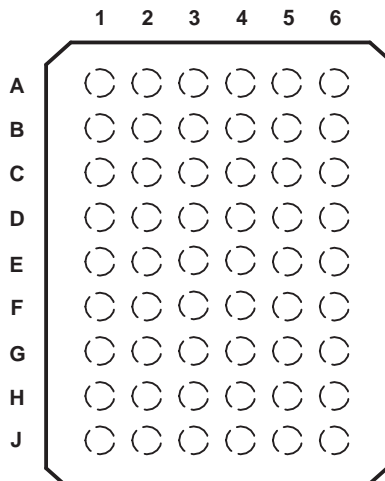

**TERMINAL ASSIGNMENTS⁽¹⁾
(54-Ball GRD/ZRD Package)**

	1	2	3	4	5	6
A	1Q1	NC	1 \overline{OE}	1CLK	NC	1D1
B	1Q3	1Q2	NC	NC	1D2	1D3
C	1Q5	1Q4	V _{CC}	V _{CC}	1D4	1D5
D	1Q7	1Q6	GND	GND	1D6	1D7
E	2Q1	1Q8	GND	GND	1D8	2D1
F	2Q3	2Q2	GND	GND	2D2	2D3
G	2Q5	2Q4	V _{CC}	V _{CC}	2D4	2D5
H	2Q7	2Q6	NC	NC	2D6	2D7
J	2Q8	NC	2 \overline{OE}	2CLK	NC	2D8

(1) NC – No internal connection

**FUNCTION TABLE
(EACH FLIP-FLOP)**

INPUTS			OUTPUT Q
\overline{OE}	CLK	D	
L	↑	H	H
L	↑	L	L
L	H or L	X	Q ₀
H	X	X	Z

SN54LVTH16374, SN74LVTH16374

3.3-V ABT 16-BIT EDGE-TRIGGERED D-TYPE FLIP-FLOPS WITH 3-STATE OUTPUTS

SCBS145Q—MAY 1992—REVISED DECEMBER 2006

LOGIC DIAGRAM (POSITIVE LOGIC)

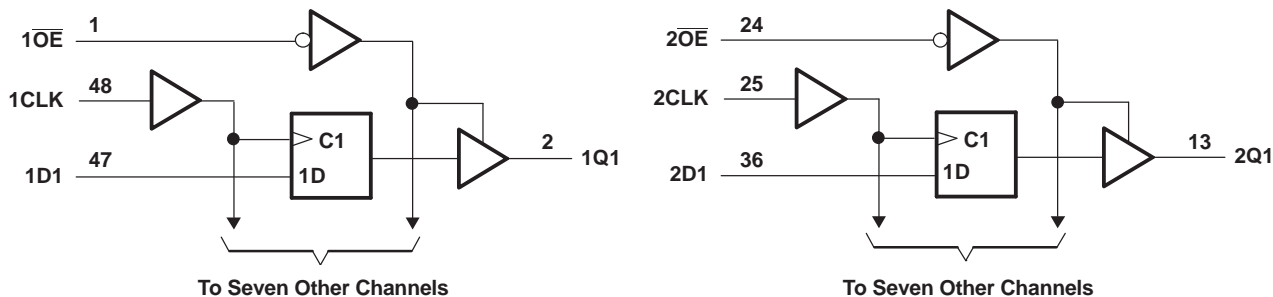

Pin numbers shown are for the DGG, DL, and WD packages.

Absolute Maximum Ratings⁽¹⁾

over operating free-air temperature range (unless otherwise noted)

		MIN	MAX	UNIT
V_{CC}	Supply voltage range	-0.5	4.6	V
V_I	Input voltage range ⁽²⁾	-0.5	7	V
V_O	Voltage range applied to any output in the high-impedance or power-off state ⁽²⁾	-0.5	7	V
V_O	Voltage range applied to any output in the high state ⁽²⁾	-0.5	$V_{CC} + 0.5$	V
I_O	Current into any output in the low state	SN54LVTH16374	96	mA
		SN74LVTH16374	128	
I_O	Current into any output in the high state ⁽³⁾	SN54LVTH16374	48	mA
		SN74LVTH16374	64	
I_{IK}	Input clamp current	$V_I < 0$	-50	mA
I_{OK}	Output clamp current	$V_O < 0$	-50	mA
θ_{JA}	Package thermal impedance ⁽⁴⁾	DGG package	70	°C/W
		DL package	63	
		GQL/ZQL package	42	
		GRD/ZRD package	36	
T_{stg}	Storage temperature range	-65	150	°C

(1) Stresses beyond those listed under "absolute maximum ratings" may cause permanent damage to the device. These are stress ratings only, and functional operation of the device at these or any other conditions beyond those indicated under "recommended operating conditions" is not implied. Exposure to absolute-maximum-rated conditions for extended periods may affect device reliability.

(2) The input and output negative-voltage ratings may be exceeded if the input and output clamp-current ratings are observed.

(3) This current flows only when the output is in the high state and $V_O > V_{CC}$.

(4) The package thermal impedance is calculated in accordance with JESD 51-7.

Recommended Operating Conditions⁽¹⁾

		SN54LVTH16374		SN74LVTH16374		UNIT
		MIN	MAX	MIN	MAX	
V _{CC}	Supply voltage	2.7	3.6	2.7	3.6	V
V _{IH}	High-level input voltage	2		2		V
V _{IL}	Low-level input voltage		0.8		0.8	V
V _I	Input voltage		5.5		5.5	V
I _{OH}	High-level output current		–24		–32	mA
I _{OL}	Low-level output current		48		64	mA
Δt/Δv	Input transition rise or fall rate		10		10	ns/V
	Outputs enabled					
Δt/ΔV _{CC}	Power-up ramp rate	200		200		μs/V
T _A	Operating free-air temperature	–55	125	–40	85	°C

(1) All unused control inputs of the device must be held at V_{CC} or GND to ensure proper device operation. Refer to the TI application report, *Implications of Slow or Floating CMOS Inputs*, literature number SCBA004.

SN54LVTH16374, SN74LVTH16374

3.3-V ABT 16-BIT EDGE-TRIGGERED D-TYPE FLIP-FLOPS WITH 3-STATE OUTPUTS

SCBS145Q–MAY 1992–REVISED DECEMBER 2006

Electrical Characteristics

over recommended operating free-air temperature range (unless otherwise noted)

PARAMETER	TEST CONDITIONS		SN54LVTH16374			SN74LVTH16374			UNIT
			MIN	TYP ⁽¹⁾	MAX	MIN	TYP ⁽¹⁾	MAX	
V_{IK}	$V_{CC} = 2.7\text{ V}$, $I_I = -18\text{ mA}$		-1.2			-1.2			V
V_{OH}	$V_{CC} = 2.7\text{ V to } 3.6\text{ V}$, $I_{OH} = -100\text{ }\mu\text{A}$		$V_{CC} - 0.2$			$V_{CC} - 0.2$			V
	$V_{CC} = 2.7\text{ V}$, $I_{OH} = -8\text{ mA}$		2.4			2.4			
	$V_{CC} = 3\text{ V}$	$I_{OH} = -24\text{ mA}$	2			2			
V_{OL}	$V_{CC} = 2.7\text{ V}$	$I_{OL} = 100\text{ }\mu\text{A}$	0.2			0.2			V
		$I_{OL} = 24\text{ mA}$	0.5			0.5			
	$V_{CC} = 3\text{ V}$	$I_{OL} = 16\text{ mA}$	0.4			0.4			
		$I_{OL} = 32\text{ mA}$	0.5			0.5			
		$I_{OL} = 48\text{ mA}$	0.55			0.55			
		$I_{OL} = 64\text{ mA}$				0.55			
I_I	$V_{CC} = 0\text{ or } 3.6\text{ V}$, $V_I = 5.5\text{ V}$		10			10			μA
	Control inputs	$V_{CC} = 3.6\text{ V}$, $V_I = V_{CC}\text{ or GND}$	± 1			± 1			
	Data inputs	$V_{CC} = 3.6\text{ V}$	$V_I = V_{CC}$	1		1			
		$V_I = 0$	-5		-5				
I_{off}	$V_{CC} = 0$, $V_I\text{ or } V_O = 0\text{ to } 4.5\text{ V}$					± 100			μA
$I_{I(\text{hold})}$	Data inputs	$V_{CC} = 3\text{ V}$	$V_I = 0.8\text{ V}$	75		75		μA	
			$V_I = 2\text{ V}$	-75		-75			
		$V_{CC} = 3.6\text{ V}$, ⁽²⁾	$V_I = 0\text{ to } 3.6\text{ V}$			500			
I_{OZH}	$V_{CC} = 3.6\text{ V}$, $V_O = 3\text{ V}$		5			5			μA
I_{OZL}	$V_{CC} = 3.6\text{ V}$, $V_O = 0.5\text{ V}$		-5			-5			μA
I_{OZPU}	$V_{CC} = 0\text{ to } 1.5\text{ V}$, $V_O = 0.5\text{ V to } 3\text{ V}$, $OE = \text{don't care}$		± 100 ⁽³⁾			± 100			μA
I_{OZPD}	$V_{CC} = 1.5\text{ V to } 0$, $V_O = 0.5\text{ V to } 3\text{ V}$, $OE = \text{don't care}$		± 100 ⁽³⁾			± 100			μA
I_{CC}	$V_{CC} = 3.6\text{ V}$, $I_O = 0$, $V_I = V_{CC}\text{ or GND}$	Outputs high	0.19		0.19		mA		
		Outputs low	5		5				
		Outputs disabled	0.19		0.19				
ΔI_{CC} ⁽⁴⁾	$V_{CC} = 3\text{ V to } 3.6\text{ V}$, One input at $V_{CC} - 0.6\text{ V}$, Other inputs at $V_{CC}\text{ or GND}$		0.2			0.2			mA
C_I	$V_I = 3\text{ V or } 0$		3			3			pF
C_O	$V_O = 3\text{ V or } 0$		9			9			pF

(1) All typical values are at $V_{CC} = 3.3\text{ V}$, $T_A = 25^\circ\text{C}$.

(2) This is the bus-hold maximum dynamic current. It is the minimum overdrive current required to switch the input from one state to another.

(3) On products compliant to MIL-PRF-38535, this parameter is not production tested.

(4) This is the increase in supply current for each input that is at the specified TTL voltage level, rather than V_{CC} or GND.

Timing Requirements

 over recommended operating free-air temperature range (unless otherwise noted) (see [Figure 1](#))

			SN54LVTH16374				SN74LVTH16374				UNIT
			$V_{CC} = 3.3\text{ V} \pm 0.3\text{ V}$		$V_{CC} = 2.7\text{ V}$		$V_{CC} = 3.3\text{ V} \pm 0.3\text{ V}$		$V_{CC} = 2.7\text{ V}$		
			MIN	MAX	MIN	MAX	MIN	MAX	MIN	MAX	
f_{clock}	Clock frequency		160		160		160		160		MHz
t_w	Pulse duration, CLK high or low		3		3		3		3		ns
t_{su}	Setup time, data before CLK \uparrow	High or low	2.9		3.3		1.8		2		ns
t_h	Hold time, data after CLK \uparrow	High or low	0.8		0.2		0.8		0.1		ns

Switching Characteristics

 over recommended operating free-air temperature range, $C_L = 50\text{ pF}$ (unless otherwise noted) (see [Figure 1](#))

PARAMETER	FROM (INPUT)	TO (OUTPUT)	SN54LVTH16374				SN74LVTH16374				UNIT
			$V_{CC} = 3.3\text{ V} \pm 0.3\text{ V}$		$V_{CC} = 2.7\text{ V}$		$V_{CC} = 3.3\text{ V} \pm 0.3\text{ V}$			$V_{CC} = 2.7\text{ V}$	
			MIN	MAX	MIN	MAX	MIN	TYP ⁽¹⁾	MAX	MIN	
f_{max}			160		160		160			160	MHz
t_{PLH}	CLK	Q	1.4 5.6		6.2		1.9 3 4.5			5.2	ns
t_{PHL}			1.7 4.8		5		2.1 2.9 4			4.2	
t_{PZH}	$\overline{\text{OE}}$	Q	1 5.6		6.4		1.5 2.8 4.5			5.4	ns
t_{PZL}			1.4 5.5		6.2		1.5 2.8 4.4			5	
t_{PHZ}	$\overline{\text{OE}}$	Q	1 6.4		6.9		2.4 3.5 5			5.4	ns
t_{PLZ}			1.7 5		5.2		2 3.2 4.6			4.8	
$t_{\text{sk(LH)}}$							0.5				ns
$t_{\text{sk(HL)}}$							0.5				

 (1) All typical values are at $V_{CC} = 3.3\text{ V}$, $T_A = 25^\circ\text{C}$.

SN54LVTH16374, SN74LVTH16374

3.3-V ABT 16-BIT EDGE-TRIGGERED D-TYPE FLIP-FLOPS WITH 3-STATE OUTPUTS

SCBS145Q—MAY 1992—REVISED DECEMBER 2006

PARAMETER MEASUREMENT INFORMATION

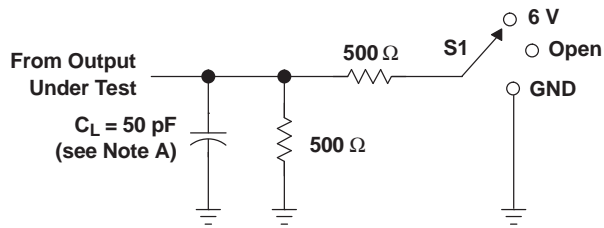

LOAD CIRCUIT

TEST	S1
t_{PLH}/t_{PHL}	Open
t_{PLZ}/t_{PZL}	6 V
t_{PHZ}/t_{PZH}	GND

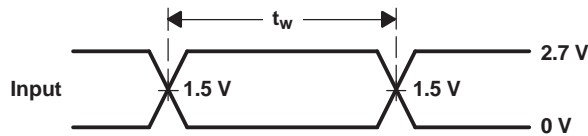

VOLTAGE WAVEFORMS
PULSE DURATION

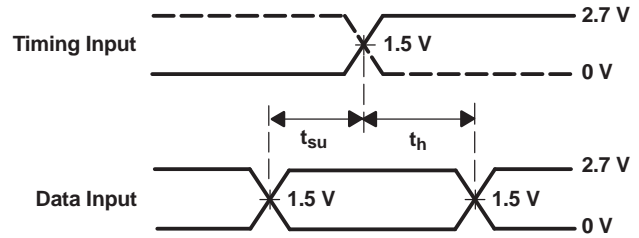

VOLTAGE WAVEFORMS
SETUP AND HOLD TIMES

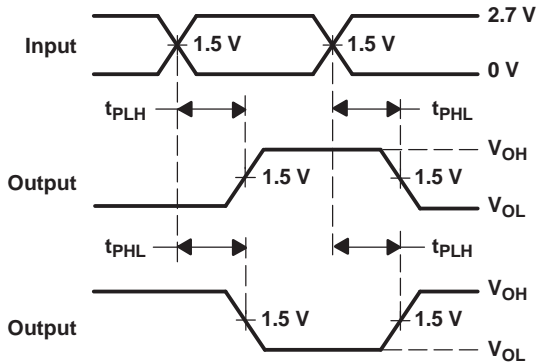

VOLTAGE WAVEFORMS
PROPAGATION DELAY TIMES
INVERTING AND NONINVERTING OUTPUTS

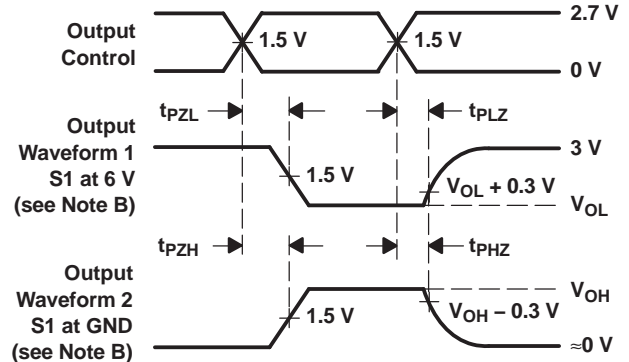

VOLTAGE WAVEFORMS
ENABLE AND DISABLE TIMES
LOW- AND HIGH-LEVEL ENABLING

- NOTES: A. C_L includes probe and jig capacitance.
- B. Waveform 1 is for an output with internal conditions such that the output is low, except when disabled by the output control. Waveform 2 is for an output with internal conditions such that the output is high, except when disabled by the output control.
- C. All input pulses are supplied by generators having the following characteristics: $PRR \leq 10 \text{ MHz}$, $Z_O = 50 \Omega$, $t_r \leq 2.5 \text{ ns}$, $t_f \leq 2.5 \text{ ns}$.
- D. The outputs are measured one at a time, with one transition per measurement.

Figure 1. Load Circuit and Voltage Waveforms

PACKAGING INFORMATION

Orderable Device	Status ⁽¹⁾	Package Type	Package Drawing	Pins	Package Qty	Eco Plan ⁽²⁾	Lead/Ball Finish	MSL Peak Temp ⁽³⁾
5962-9564701QXA	ACTIVE	CFP	WD	48	1	TBD	A42 SNPB	N / A for Pkg Type
74LVTH16374DGGRG4	ACTIVE	TSSOP	DGG	48	2000	Green (RoHS & no Sb/Br)	CU NIPDAU	Level-1-260C-UNLIM
74LVTH16374DLRG4	ACTIVE	SSOP	DL	48	1000	Green (RoHS & no Sb/Br)	CU NIPDAU	Level-1-260C-UNLIM
SN74LVTH16374DGGR	ACTIVE	TSSOP	DGG	48	2000	Green (RoHS & no Sb/Br)	CU NIPDAU	Level-1-260C-UNLIM
SN74LVTH16374DL	ACTIVE	SSOP	DL	48	25	Green (RoHS & no Sb/Br)	CU NIPDAU	Level-1-260C-UNLIM
SN74LVTH16374DLG4	ACTIVE	SSOP	DL	48	25	Green (RoHS & no Sb/Br)	CU NIPDAU	Level-1-260C-UNLIM
SN74LVTH16374DLR	ACTIVE	SSOP	DL	48	1000	Green (RoHS & no Sb/Br)	CU NIPDAU	Level-1-260C-UNLIM
SN74LVTH16374GQLR	ACTIVE	BGA MICROSTAR JUNIOR	GQL	56	1000	TBD	SNPB	Level-1-240C-UNLIM
SN74LVTH16374GRDR	ACTIVE	BGA MICROSTAR JUNIOR	GRD	54	1000	TBD	SNPB	Level-1-240C-UNLIM
SN74LVTH16374ZQLR	ACTIVE	BGA MICROSTAR JUNIOR	ZQL	56	1000	Green (RoHS & no Sb/Br)	SNAGCU	Level-1-260C-UNLIM
SN74LVTH16374ZRDR	ACTIVE	BGA MICROSTAR JUNIOR	ZRD	54	1000	Green (RoHS & no Sb/Br)	SNAGCU	Level-1-260C-UNLIM
SNJ54LVTH16374WD	ACTIVE	CFP	WD	48	1	TBD	A42 SNPB	N / A for Pkg Type

⁽¹⁾ The marketing status values are defined as follows:

ACTIVE: Product device recommended for new designs.

LIFEBUY: TI has announced that the device will be discontinued, and a lifetime-buy period is in effect.

NRND: Not recommended for new designs. Device is in production to support existing customers, but TI does not recommend using this part in a new design.

PREVIEW: Device has been announced but is not in production. Samples may or may not be available.

OBSOLETE: TI has discontinued the production of the device.

⁽²⁾ Eco Plan - The planned eco-friendly classification: Pb-Free (RoHS), Pb-Free (RoHS Exempt), or Green (RoHS & no Sb/Br) - please check <http://www.ti.com/productcontent> for the latest availability information and additional product content details.

TBD: The Pb-Free/Green conversion plan has not been defined.

Pb-Free (RoHS): TI's terms "Lead-Free" or "Pb-Free" mean semiconductor products that are compatible with the current RoHS requirements for all 6 substances, including the requirement that lead not exceed 0.1% by weight in homogeneous materials. Where designed to be soldered at high temperatures, TI Pb-Free products are suitable for use in specified lead-free processes.

Pb-Free (RoHS Exempt): This component has a RoHS exemption for either 1) lead-based flip-chip solder bumps used between the die and package, or 2) lead-based die adhesive used between the die and leadframe. The component is otherwise considered Pb-Free (RoHS compatible) as defined above.

Green (RoHS & no Sb/Br): TI defines "Green" to mean Pb-Free (RoHS compatible), and free of Bromine (Br) and Antimony (Sb) based flame retardants (Br or Sb do not exceed 0.1% by weight in homogeneous material)

⁽³⁾ MSL, Peak Temp. -- The Moisture Sensitivity Level rating according to the JEDEC industry standard classifications, and peak solder temperature.

Important Information and Disclaimer:The information provided on this page represents TI's knowledge and belief as of the date that it is provided. TI bases its knowledge and belief on information provided by third parties, and makes no representation or warranty as to the accuracy of such information. Efforts are underway to better integrate information from third parties. TI has taken and continues to take reasonable steps to provide representative and accurate information but may not have conducted destructive testing or chemical analysis on incoming materials and chemicals. TI and TI suppliers consider certain information to be proprietary, and thus CAS numbers and other limited information may not be available for release.

In no event shall TI's liability arising out of such information exceed the total purchase price of the TI part(s) at issue in this document sold by TI to Customer on an annual basis.

WD (R-GDFP-F**)

CERAMIC DUAL FLATPACK

48 LEADS SHOWN



- NOTES: A. All linear dimensions are in inches (millimeters).
 B. This drawing is subject to change without notice.
 C. This package can be hermetically sealed with a ceramic lid using glass frit.
 D. Index point is provided on cap for terminal identification only
 E. Falls within MIL STD 1835: GDFP1-F48 and JEDEC MO-146AA
 GDFP1-F56 and JEDEC MO-146AB

ZQL (R-PBGA-N56)

PLASTIC BALL GRID ARRAY

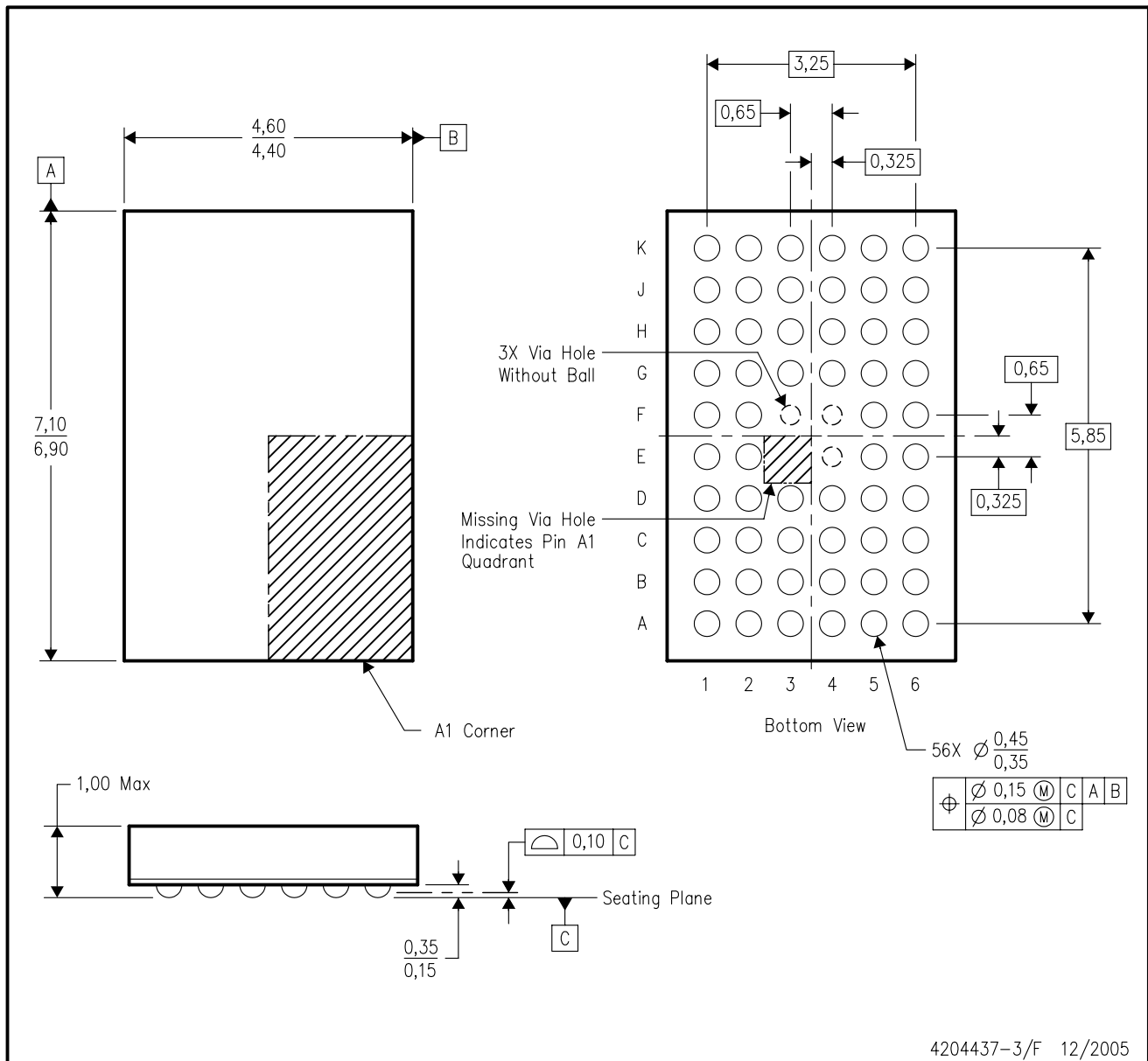

- NOTES:
- All linear dimensions are in millimeters. Dimensioning and tolerancing per ASME Y14.5M-1994.
 - This drawing is subject to change without notice.
 - Falls within JEDEC MO-225 variation BA.
 - This package is lead-free. Refer to the 56 GQL package (drawing 4200583) for tin-lead (SnPb).

GRD (R-PBGA-N54)

PLASTIC BALL GRID ARRAY

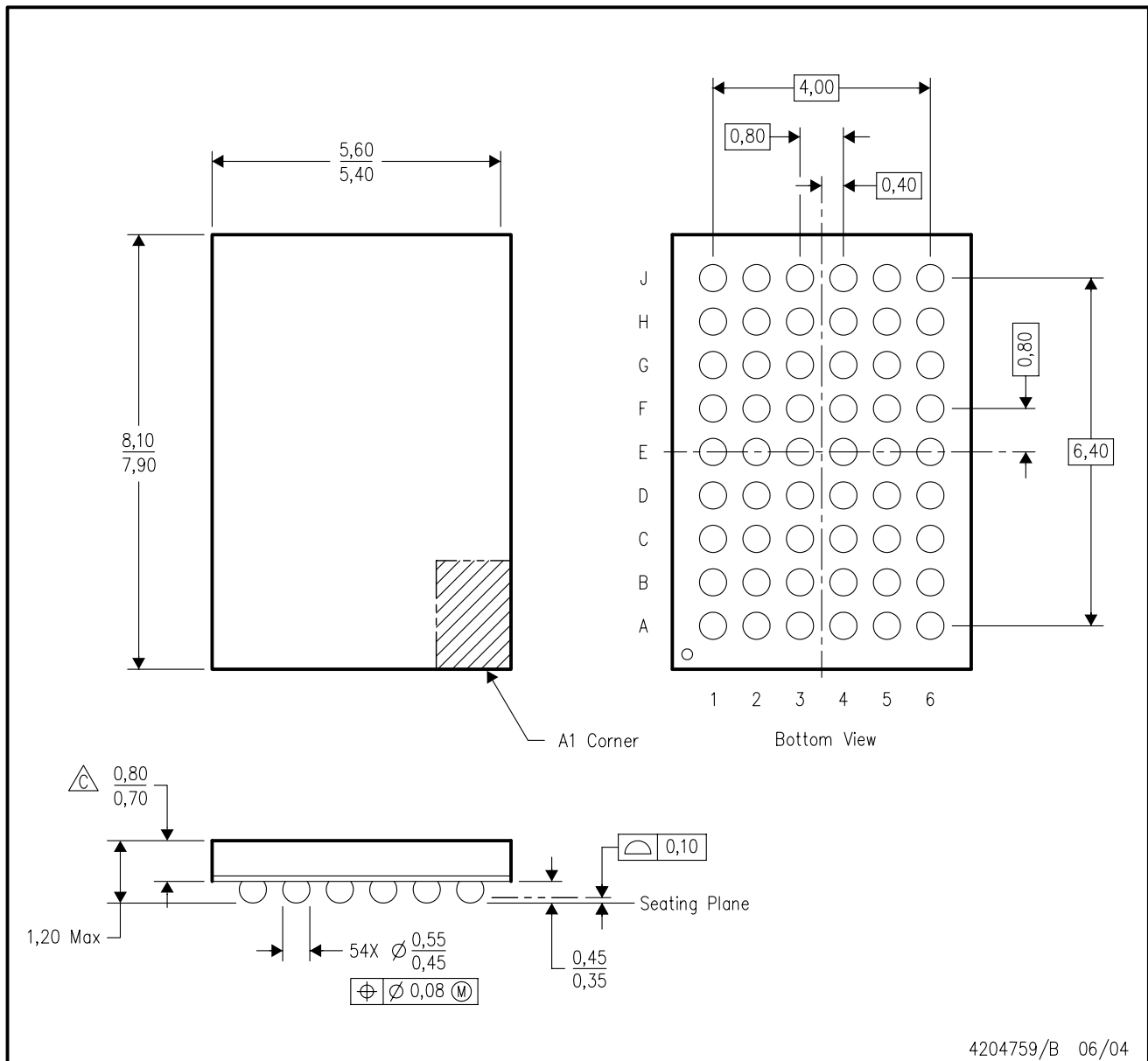

- NOTES:
- A. All linear dimensions are in millimeters.
 - B. This drawing is subject to change without notice.
 -  Falls within JEDEC MO-205 variation DD.
 - D. This package is tin-lead (SnPb). Refer to the 54 ZRD package (drawing 4204760) for lead-free.

ZRD (R-PBGA-N54)

PLASTIC BALL GRID ARRAY



- NOTES:
- A. All linear dimensions are in millimeters.
 - B. This drawing is subject to change without notice.
 -  Falls within JEDEC MO-205 variation DD.
 - D. This package is lead-free. Refer to the 54 GRD package (drawing 4204759) for tin-lead (SnPb).

GQL (R-PBGA-N56)

PLASTIC BALL GRID ARRAY

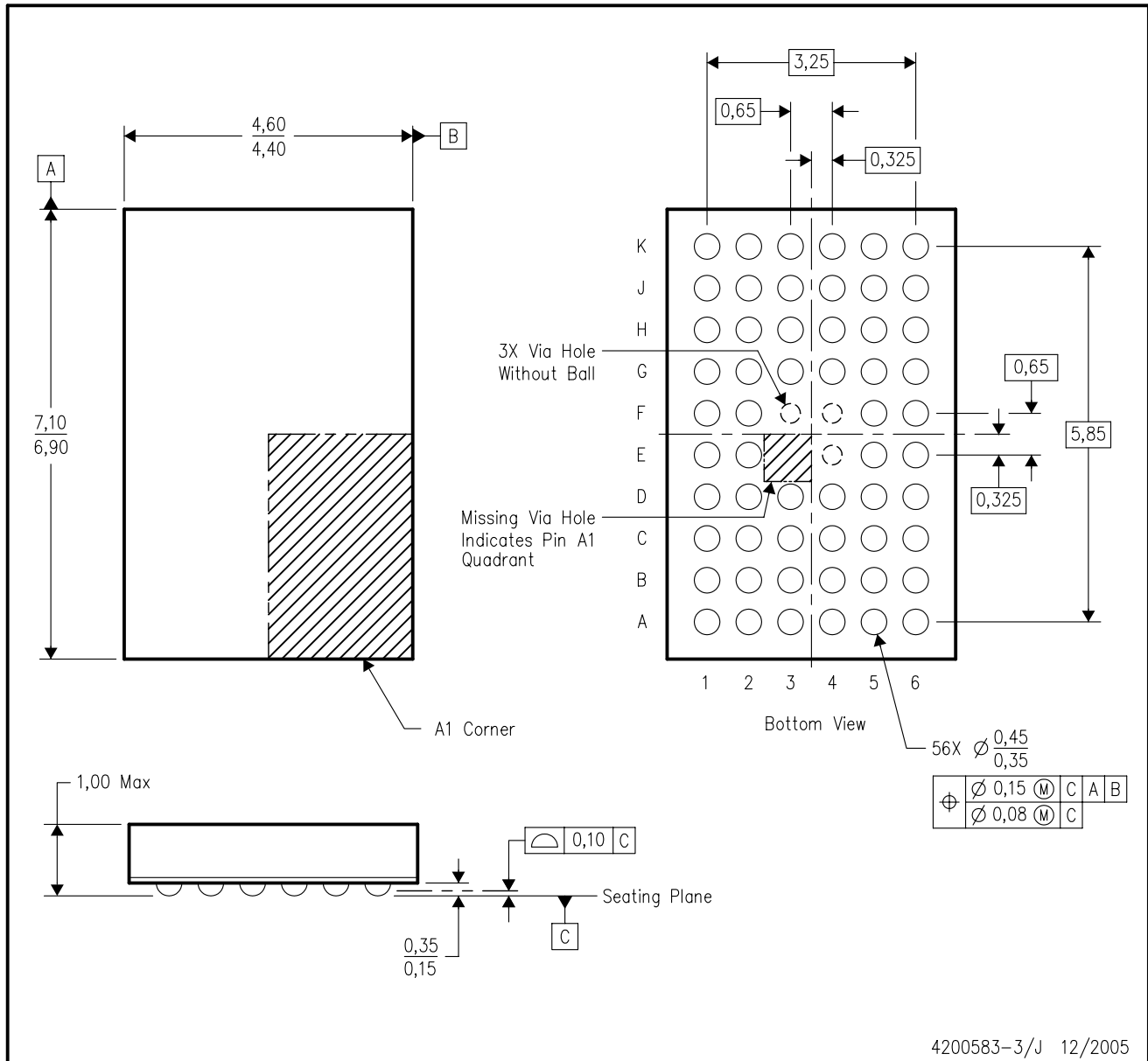

- NOTES:
- A. All linear dimensions are in millimeters. Dimensioning and tolerancing per ASME Y14.5M-1994.
 - B. This drawing is subject to change without notice.
 - C. Falls within JEDEC MO-225 variation BA.
 - D. This package is tin-lead (SnPb). Refer to the 56 ZQL package (drawing 4204437) for lead-free.

DL (R-PDSO-G**)

PLASTIC SMALL-OUTLINE PACKAGE

48 PINS SHOWN



- NOTES: A. All linear dimensions are in inches (millimeters).
 B. This drawing is subject to change without notice.
 C. Body dimensions do not include mold flash or protrusion not to exceed 0.006 (0,15).
 D. Falls within JEDEC MO-118

DGG (R-PDSO-G**)

PLASTIC SMALL-OUTLINE PACKAGE

48 PINS SHOWN



- NOTES: A. All linear dimensions are in millimeters.
 B. This drawing is subject to change without notice.
 C. Body dimensions do not include mold protrusion not to exceed 0,15.
 D. Falls within JEDEC MO-153

IMPORTANT NOTICE

Texas Instruments Incorporated and its subsidiaries (TI) reserve the right to make corrections, modifications, enhancements, improvements, and other changes to its products and services at any time and to discontinue any product or service without notice. Customers should obtain the latest relevant information before placing orders and should verify that such information is current and complete. All products are sold subject to TI's terms and conditions of sale supplied at the time of order acknowledgment.

TI warrants performance of its hardware products to the specifications applicable at the time of sale in accordance with TI's standard warranty. Testing and other quality control techniques are used to the extent TI deems necessary to support this warranty. Except where mandated by government requirements, testing of all parameters of each product is not necessarily performed.

TI assumes no liability for applications assistance or customer product design. Customers are responsible for their products and applications using TI components. To minimize the risks associated with customer products and applications, customers should provide adequate design and operating safeguards.

TI does not warrant or represent that any license, either express or implied, is granted under any TI patent right, copyright, mask work right, or other TI intellectual property right relating to any combination, machine, or process in which TI products or services are used. Information published by TI regarding third-party products or services does not constitute a license from TI to use such products or services or a warranty or endorsement thereof. Use of such information may require a license from a third party under the patents or other intellectual property of the third party, or a license from TI under the patents or other intellectual property of TI.

Reproduction of information in TI data books or data sheets is permissible only if reproduction is without alteration and is accompanied by all associated warranties, conditions, limitations, and notices. Reproduction of this information with alteration is an unfair and deceptive business practice. TI is not responsible or liable for such altered documentation.

Resale of TI products or services with statements different from or beyond the parameters stated by TI for that product or service voids all express and any implied warranties for the associated TI product or service and is an unfair and deceptive business practice. TI is not responsible or liable for any such statements.

Following are URLs where you can obtain information on other Texas Instruments products and application solutions:

Products		Applications	
Amplifiers	amplifier.ti.com	Audio	www.ti.com/audio
Data Converters	dataconverter.ti.com	Automotive	www.ti.com/automotive
DSP	dsp.ti.com	Broadband	www.ti.com/broadband
Interface	interface.ti.com	Digital Control	www.ti.com/digitalcontrol
Logic	logic.ti.com	Military	www.ti.com/military
Power Mgmt	power.ti.com	Optical Networking	www.ti.com/opticalnetwork
Microcontrollers	microcontroller.ti.com	Security	www.ti.com/security
Low Power Wireless	www.ti.com/lpw	Telephony	www.ti.com/telephony
		Video & Imaging	www.ti.com/video
		Wireless	www.ti.com/wireless

Mailing Address: Texas Instruments
Post Office Box 655303 Dallas, Texas 75265