



Features

- Input Voltage Range: 36V to 75V
- 1500 VDC Isolation
- On/Off Control
- V_o Adjust
- Differential Remote Sense
- Current Limit
- Short-Circuit Protection
- Over-Temperature Shutdown
- Undervoltage Lockout
- UL1950 Recognized
- Flexible SIP Package
- CSA 22.2 950 Certified
- EN60950 Approved
- VDE Licensed
- 4.9 x10⁶ Hrs MTBF
- Meets FCC Class A Radiated Limits

Description

The PT3320 series is a single-output isolated DC/DC converter, housed in a 19-pin aluminum SIP package. These modules are UL, CSA, and VDE approved for telecom applications, and rated at 30 watts or 8 A. Standard output voltages range from 1.8 V to 15 V, each adjustable by up to $\pm 10\%$ of nominal.

Operating features include a remote on/off control, an under-voltage-lockout (UVLO), and a differential remote sense. The PT3320 series also incorporates many protection features. These include output current limit, short-circuit protection, and over-temperature shutdown.

A 330 μ F of output capacitance is required for proper operation.

Ordering Information

- PT3321□ = 3.3V/8A (26.4W)
 PT3322□ = 5.0V/6A
 PT3323□ = 12.0V/2.5A
 PT3324□ = 15.0V/2A
 PT3325□ = 2.0V/8A (16W)
 PT3326□ = 2.5V/8A (20W)
 PT3327□ = 1.8V/8A (14.4W)
 PT3328□ = 5.2V/6A

PT Series Suffix (PT1234 x)

Case/Pin Configuration	Order Suffix	Package Code *
Vertical	N	(EHG)
Horizontal	A	(EHH)
SMD	C	(EHJ)

* Previously known as package styles 840 & 850.

(Reference the applicable package code drawing for the dimensions and PC board layout)

Pin-Out Information

Pin	Function
1	Do Not Use
2	Remote On/Off †
3	Do Not Use
4	-V _{in}
5	-V _{in}
6	-V _{in}
7	+V _{in}
8	+V _{in}
9	+V _{in}
10	-V _o
11	-V _o
12	-V _o
13	-Remote Sense
14	+V _o
15	+V _o
16	+V _o
17	+V _o
18	V _o Adjust †
19	+Remote Sense

† For more information, see application notes.

Standard Application

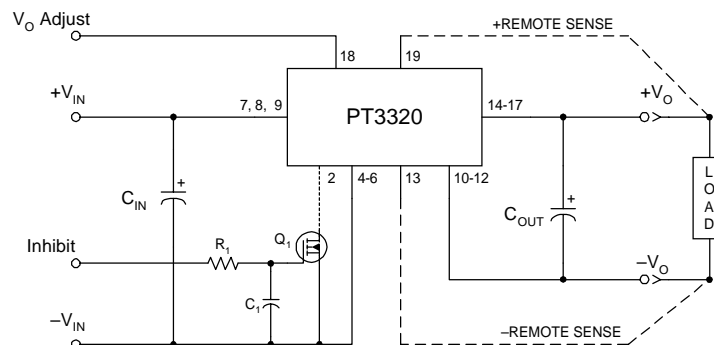

- C_{in} = Optional 100 μ F/100V electrolytic
- C_{out} = Required 330 μ F electrolytic (See Notes)
- Q_1 = N-Channel MOSFET
- R_1/C_1 = Optional (see application notes)

PT3320 Series

30-W 48-V Input
Isolated DC/DC Converter

Specifications (Unless otherwise stated, $T_a = 25^\circ\text{C}$, $V_{in} = 48\text{V}$, $C_{out} = 330\mu\text{F}$, and $I_o = I_{o,max}$)

Characteristic	Symbol	Conditions	PT3320 SERIES			Units	
			Min	Typ	Max		
Output Current	I_o	Over V_{in} range	$V_o = 15\text{V}$ $V_o = 12\text{V}$ $V_o = 5.0\text{V}$ $V_o \leq 3.3\text{V}$	0.1 (1) 0.1 (1) 0.25 (1) 0.25 (1)	— — — —	2.0 2.5 6.0 8.0	A
Input Voltage Range	V_{in}	Over I_o Range		36.0	48.0	75.0	V
Set Point Voltage Tolerance	V_o tol		$V_o \geq 5.0\text{V}$ $V_o \leq 3.3\text{V}$	— —	± 1 ± 33	± 1.5 ± 50	$\%V_o$ mV
Temperature Variation	Reg_{temp}	$-40^\circ \leq T_a \leq +85^\circ\text{C}$		—	± 0.5	—	$\%V_o$
Line Regulation	Reg_{line}	Over V_{in} range	$V_o \geq 5.0\text{V}$ $V_o \leq 3.3\text{V}$	— —	± 0.2 ± 7	± 1.0 ± 33	$\%V_o$ mV
Load Regulation	Reg_{load}	Over I_o range	$V_o \geq 5.0\text{V}$ $V_o \leq 3.3\text{V}$	— —	± 0.4 ± 13	± 1.0 ± 33	$\%V_o$ mV
Total Output Voltage Variation	$\Delta V_{o,tot}$	Includes set-point, line, load, $-40^\circ \leq T_a \leq +85^\circ\text{C}$	$V_o \geq 5.0\text{V}$ $V_o \leq 3.3\text{V}$	— —	± 2 ± 67	— —	$\%V_o$ mV
Efficiency	η		$V_o = 15\text{V}$ $V_o = 12\text{V}$ $V_o = 5.0\text{V}$ $V_o = 3.3\text{V}$ $V_o = 1.8\text{V}$	— — — — —	85 87 84 80 69	— — — — —	
V_o Ripple (pk-pk)	V_r	20MHz bandwidth	$V_o \geq 5.0\text{V}$ $V_o \leq 3.3\text{V}$	— —	1.0 50	2.0 75	$\%V_o$ mV _{pp}
Transient Response	t_{tr} ΔV_{tr}	0.1A/ μs load step, 50% to 100% $I_{o,max}$ V_o over/undershoot	$V_o \geq 5.0\text{V}$ $V_o \leq 3.3\text{V}$	— —	100 ± 100	200 ± 150	μs $\%V_o$ mV
Short Circuit Current	I_{sc}			—	$2 \times I_{o,max}$	—	A
Switching Frequency	f_s	Over V_{in} range	$V_o > 10\text{V}$ $V_o < 10\text{V}$	400 600	500 750	600 900	kHz
Under-Voltage Lockout	UVLO	V_{in} increasing V_{in} decreasing		— —	34 33	— —	V
Remote On/Off Input (pin 2)		Referenced to $-V_{in}$ (pins 4–6)					
Input High Voltage	V_{IH}			2.5	—	15 (2)	V
Input Low Voltage	V_{IL}			–0.2	—	+0.8	V
Input Low Current	I_{IL}			–3	–6	–10	μA
Standby Input Current	$I_{in, standby}$	pins 2 & 4 connected		—	8	16	mA
Internal Input Capacitance	C_{in}			—	0.66	—	μF
External Output Capacitance	C_{out}	Between $+V_o$ and $-V_o$	$V_o \geq 9\text{V}$ $V_o \leq 5\text{V}$	260 260	330 330	600 (3) 1,000 (3)	μF
Isolation Voltage		Input-output/input-case		1500	—	—	V _{dc}
Capacitance		Input-output		—	1200	—	pF
Resistance		Input-output		10	—	—	M Ω
Operating Temperature Range	T_a	Over V_{in} range		–40 (4)	—	+85 (5)	$^\circ\text{C}$
Maximum Case Temperature	T_c			—	—	100	$^\circ\text{C}$
Storage Temperature Range	T_s			–40	—	+125	$^\circ\text{C}$
Reliability	MTBF	Per Bellcore TR-332 50% stress, $T_a = 40^\circ\text{C}$, ground benign		4.9	—	—	10 ⁶ Hrs
Mechanical Shock	—	Per Mil-Std-883D, method 2002.3, 1mS, half-sine, mounted to a fixture		—	500	—	G's
Mechanical Vibration	—	Per Mil-Std-883D, method 2007.2, 20-2000Hz, soldered in board		—	10	—	G's
Weight	—	—		—	43	—	grams
Flammability	—	Materials meet UL 94V-0		—	—	—	

- Notes:**
- (1) The DC/DC converter will operate at no load with reduced specifications.
 - (2) The Remote On/Off input has an internal pull-up. If it is left open circuit the module will operate when input power is applied. A low-leakage (<100nA) MOSFET is recommended to control this input. The open-circuit voltage is less than 10V. See application notes for interface considerations.
 - (3) Output capacitor values are absolute. Allowances must be made for any additional de-coupling capacitors and the total external capacitor tolerance. The value of external capacitance is limited due to regulator startup current requirements. Consult the factory for further details.
 - (4) For operation below 0°C , the required external output capacitor must have temperature stable characteristics. E.g. Tantalum or Oscon® types.
 - (5) See Safe Operating Area curves or contact the factory for the appropriate thermal derating.

30-W 48-V Input
Isolated DC/DC Converter

PT3321, 3.3 VDC (See Note A)

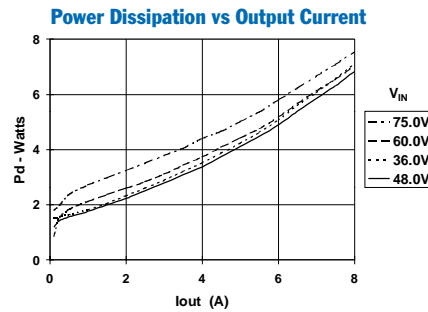
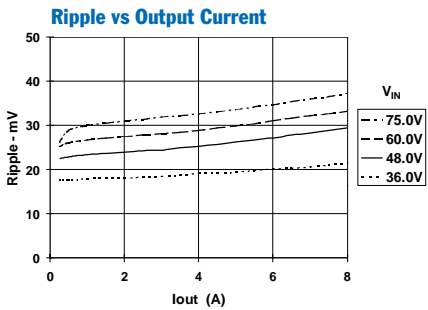
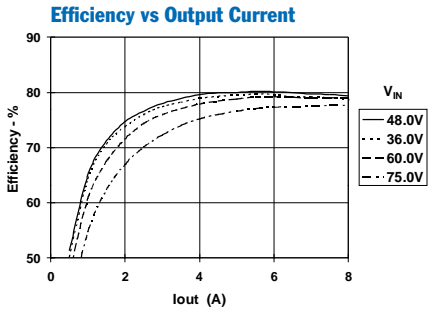

Safe Operating Area, VIN = 48V (See Note B)

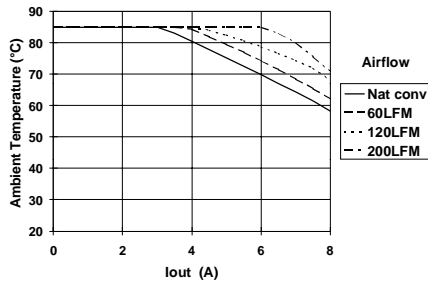

PT3322, 5.0 VDC (See Note A)

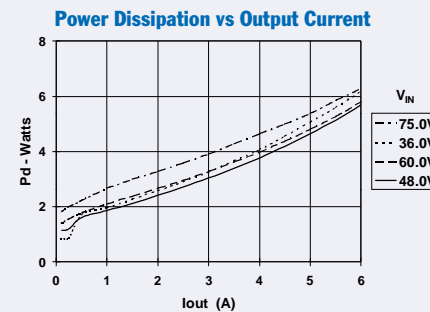
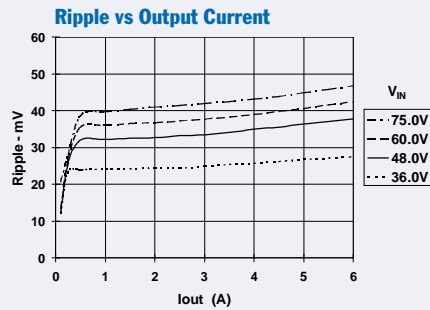
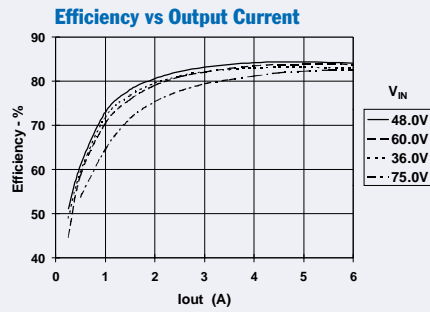

Safe Operating Area, VIN = 48V (See Note B)

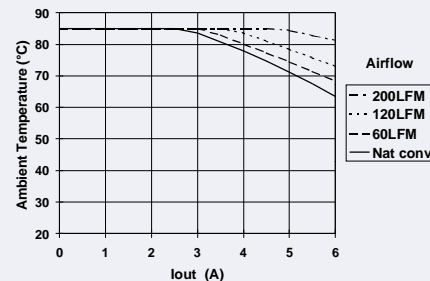

PT3323, 12.0 VDC (See Note A)

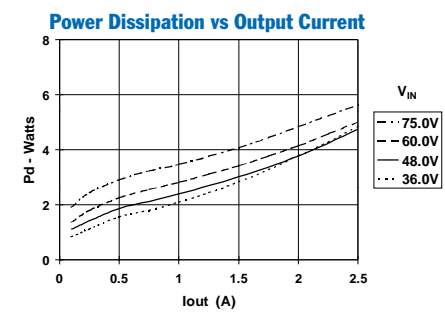
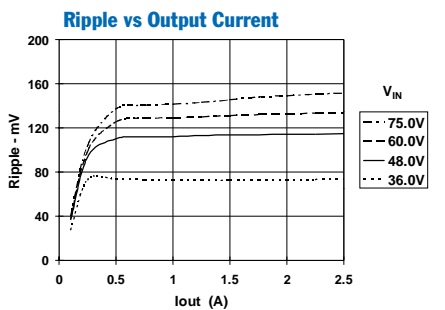
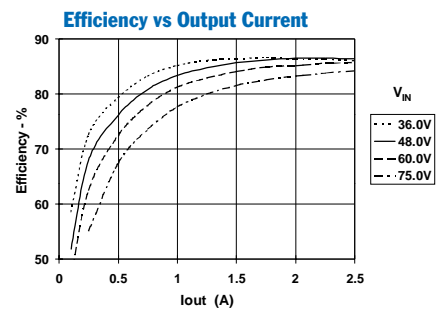

Safe Operating Area, VIN = 48V (See Note B)

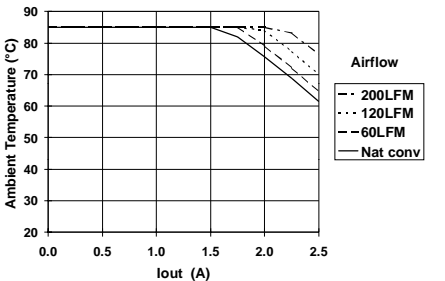

Note A: All data listed in the above graphs has been developed from actual products tested at 25°C. This data is considered typical data for the DC-DC Converter.
Note B: SOA curves represent operating conditions at which internal components are at or below manufacturer's maximum rated operating temperature.

Adjusting the Output Voltage of Power Trends' 30W Isolated DC/DC Converter Series

The factory pre-set output voltage of Power Trends' 30W series of isolated DC/DC converters may be adjusted within a nominal $\pm 10\%$ range. This is accomplished with the addition of a single external resistor. For the input voltage range specified in the data sheet, Table 1 gives the allowable adjustment range for each model as V_o (min) and V_o (max).

Adjust Up: An increase in the output voltage is obtained by adding a resistor, R_2 between V_o adjust (pin 18), and -Remote Sense (pin 13). See note 4.

Adjust Down: Add a resistor (R_1), between V_o adjust (pin 18), and +Remote Sense (pin 19).

Refer to Figure 1 and Tables 2 & 3 for both the placement and value of the required resistor, (R_1) or R_2 .

Notes:

1. Use only a single 1% resistor in either the (R_1) or R_2 location. Place the resistor as close to the ISR as possible.
2. Never connect capacitors to V_o adjust. Any capacitance added to the V_o adjust control pin will affect the stability of the ISR.

3. If the remote sense pins are not being used, the resistors (R_1) and R_2 can be connected to $+V_{out}$ or $-V_{out}$ respectively.
4. The adjusted output voltage, V_a effectively sets the voltage across pins 13 and 19 (\pm Remote Sense). When using the remote sense pins, V_{out} (measured directly across pins 10–12, and 14–17) can be significantly higher than V_a , and may exceed V_o (max). If V_a is adjusted upward of V_o (max), the minimum input voltage is increased by the same percentage as V_{out} exceeds V_o (max).

The values of (R_1) [adjust down], and R_2 [adjust up], can also be calculated using the following formulas.

$$(R_1) = \frac{K_o (V_a - V_r)}{V_r (V_o - V_a)} - R_s \quad \text{k}\Omega$$

$$R_2 = \frac{K_o}{(V_a - V_o)} - R_s \quad \text{k}\Omega$$

Where V_o = Original output voltage
 V_a = Adjusted output voltage
 V_r = Reference voltage (Table 1)
 K_o = Multiplier constant (Table 1)
 R_s = Series resistance (Table 1)

Table 1

DC/DC CONVERTER ADJUSTMENT RANGE AND FORMULA PARAMETERS

Series Pt #									
AL Case:									
24V Bus					PT3341	PT3342		PT3343	PT3344
48V Bus	PT3327	PT3325	PT3326		PT3321	PT3322		PT3323	PT3324
CU Case:									
24V Bus	PT4585				PT4581	PT4582		PT4583	PT4584
48V Bus	PT4567	PT4565	PT4566		PT4561	PT4562	PT4571	PT4563	PT4564
V_o (nom)	1.8V	1.8V	2.0V	2.5V	3.3V	5.0V	9.0V	12.0V	15.0V
V_o (min)	1.62V	1.62V	1.8V	2.25V	2.95V	4.5V	7.0V	10.8V	13.5V
V_o (max)	2.5V	1.98V	2.2V	2.75V	3.65V	5.5V	10.0V	13.2V	16.5V
V_r	1.225V	1.225V	1.225V	1.225V	1.225V	1.225V	2.5V	2.5V	2.5V
K_o (V·k Ω)	69.58	69.58	62.47	42.33	68.89	68.71	133.25	135.9	137.5
R_s (k Ω)	80.6	80.6	150.0	121.0	150.0	121.0	110	90.9	80.6

Figure 1

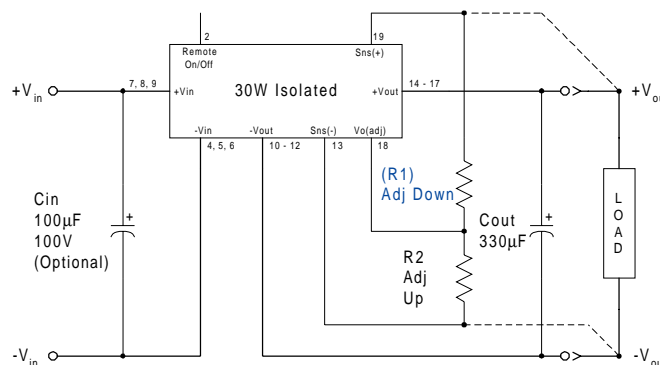

Table 2

DC/DC CONVERTER ADJUSTMENT RESISTOR VALUES

Series Pt #					
Al Case					
24V Bus					PT3341
48V Bus		PT3327	PT3325	PT3326	PT3321
CU Case					
24V Bus	PT4585				PT4581
48V Bus		PT4567	PT4565	PT4566	PT4561
Current	8A_{dc}	8A_{dc}	8A_{dc}	8A_{dc}	8A_{dc}
V_o(nom)	1.8V	1.8V	2.0V	2.5V	3.3V
V_a(req'd)					
1.65	(80.3)kΩ	(80.3)kΩ			
1.7	(189.0)kΩ	(189.0)kΩ			
1.75	(516.0)kΩ	(516.0)kΩ			
1.8					
1.85	1.31MΩ	1.31MΩ	(62.5)kΩ		
1.9	615.0kΩ	615.0kΩ	(194.0)kΩ		
1.95	383.0kΩ	383.0kΩ	(589.0)kΩ		
2.0	267.0kΩ				
2.05	198.0kΩ		1.1MΩ		
2.1	151.0kΩ		475.0kΩ		
2.15	118.0kΩ		266.0kΩ		
2.2	93.3kΩ		162.0kΩ		
2.25	74.0kΩ			(20.7)kΩ	
2.3	58.6kΩ			(64.7.0)kΩ	
2.35	45.9kΩ			(138.0)kΩ	
2.4	35.4kΩ			(285.0)kΩ	
2.45	26.4kΩ			(726.0)kΩ	
2.5	18.8kΩ				
2.55				726.0kΩ	
2.6				302.0kΩ	
2.65				161.0kΩ	
2.7				90.6kΩ	
2.75				48.3kΩ	
2.95					(127.0)kΩ
3.0					(183.0)kΩ
3.05					(261.0)kΩ
3.1					(377.0)kΩ
3.15					(572.0)kΩ
3.2					(961.0)kΩ
3.25					(2.13)MΩ
3.3					
3.35					1.23MΩ
3.4					539.0kΩ
3.45					309.0kΩ
3.5					194.0kΩ
3.55					126.0kΩ
3.6					79.6kΩ
3.65					46.8kΩ

R1 = (Blue) R2 = Black

Table 3

DC/DC CONVERTER ADJUSTMENT RESISTOR VALUES

Series Pt #

AL Case

24V Bus	PT3342
48V Bus	PT3322

	PT3343	PT3344
	PT3323	PT3324

CU Case

24V Bus	PT4582
48V Bus	PT4562

	PT4583	PT4584	
	PT4571	PT4563	PT4564

Current

V_o (nom)

V_a (req'd)

6Adc	5.0V
4.5	(246.0)kΩ
4.55	(293.0)kΩ
4.6	(352.0)kΩ
4.65	(428.0)kΩ
4.7	(529.0)kΩ
4.75	(670.0)kΩ
4.8	(882.0)kΩ
4.85	(1.23)MΩ
4.9	(1.94)MΩ
4.95	
5.0	
5.05	
5.1	566.0kΩ
5.15	337.0kΩ
5.2	223.0kΩ
5.25	154.0kΩ
5.3	108.0kΩ
5.35	75.3kΩ
5.4	50.8kΩ
5.45	31.7kΩ
5.5	16.4kΩ

3.3Adc 2.5Adc 2.0Adc

9.0V 12.0V 15.0V

V_a (req'd)	
7.0	(9.9)kΩ
7.2	(29.2)kΩ
7.4	(53.2)kΩ
7.6	(84.2)kΩ
7.8	(125.0)kΩ
8.0	(183.0)kΩ
8.2	(270.0)kΩ
8.4	(414.0)kΩ
8.6	(703.0)kΩ
8.8	(1.57)MΩ
9.0	
9.2	556.0kΩ
9.4	223.0kΩ
9.6	112.0kΩ
9.8	56.6kΩ
10.0	23.3kΩ
	•
10.8	(285.0)kΩ
11.0	(371.0)kΩ
11.2	(500.0)kΩ
11.4	(715.0)kΩ
11.6	(1.15)MΩ
11.8	
12.0	
12.2	588.0kΩ
12.4	249.0kΩ
12.6	136.0kΩ
12.8	78.9kΩ
13.0	45.0kΩ
13.2	22.3kΩ
	•
13.5	(323.0)kΩ
13.6	(355.0)kΩ
13.8	(437.0)kΩ
14.0	(522.0)kΩ
14.2	(724.0)kΩ
14.4	(1010.0)kΩ
14.6	(1.58)MΩ
14.8	
15.0	
15.2	607.0kΩ
15.4	263.0kΩ
15.6	149.0kΩ
15.8	91.3kΩ
16.0	56.9kΩ
16.5	11.1kΩ

R1 = (Blue) R2 = Black

Using Remote On/Off on Power Trends' 30W Isolated DC-DC Converter Series

Power Trends' 30W isolated series of DC/DC converters incorporate a *Remote On/Off* function. This function may be used in applications for battery conservation, power-up/shutdown sequencing, or to co-ordinate the power-up of the regulator for active in-rush current control. (See TI application reports, SLTA021, and SLUA250).

The Remote On/Off function is provided by pin 2. If pin 2 is left open-circuit, the converter provides a regulated output whenever a valid source voltage ¹ is applied between +V_{in} (pins 7-9), and -V_{in} (pins 4-6). Applying a low voltage ², with respect to -V_{in} (pin 2), disables the regulator output ³. Table 1 details the control requirements for this input. Figure 1 shows how a discrete MOSFET (Q₁) may be referenced to the negative input voltage rail to control the Remote On/Off pin.

Table 1 Remote On/Off Control Requirements ²

Parameter	min	max
Enable (V _{IH})	2.5V ⁵	15V (or open circuit) ⁴
Disable (V _{IL})	-0.3V	0.8V

Notes:

1. These converters incorporate an "Under Voltage Lockout" (UVLO) function. This function automatically holds the converter output in the "Off" state until there is sufficient input voltage for the converter to produce a regulated output. Table 2 gives the applicable UVLO thresholds.

Table 2 UVLO Thresholds

Series	UVLO Threshold	V _{in} Range
PT3320/4560	34 ± 2.0V	36 – 75V
PT3340/4580	16.5 ± 1.5V	18 – 60V

- The Remote On/Off control pin uses -V_{in} (pins 4-6) as its ground reference. All voltages specified are with respect to -V_{in}.
- When the converter output is disabled the current drawn from the input supply is typically reduced to 8mA (16mA maximum).
- The internal circuitry comprises of a high impedance (3μA -10μA) current source. The open-circuit voltage is less than 10V.
- The Remote On/Off pin is ideally controlled using devices with an open-collector (or open-drain) output. A small low-leakage MOSFET (<100nA) is recommended. A pull-up resistor is not required, but may be necessary to ensure that the Remote On/Off pin exceeds V_{IH}(min) (see Table 1). *Do not* use a pull-up resistor to the +V_{in} input, or drive the pin above V_{IH}(max).

- Keep the on/off transition to less than 1ms. This prevents erratic operation of the ISR, whereby the output voltage may drift un-regulated between 0V and the rated output voltage during power-up.
- In Figure 1, Q₁ is a low-threshold MOSFET. The components R₁ and C₁ are added to improve noise susceptibility.

Figure 1

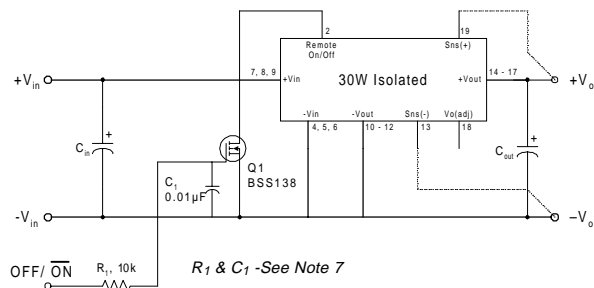

Turn-On Time: When the Remote On/Off input is left open-circuit, the output of the converter is automatically enabled when a valid input voltage ¹ is applied to the input power pins. The converter typically rises to full regulation within 30ms of the application of power (or after the release of the Remote On/Off pin with input power applied). The actual turn-on time will vary with the input voltage, output load, and the total amount of capacitance connected to the output. Using the circuit of Figure 1, Figure 2 shows the typical output voltage and input current waveforms for a PT3322/PT4562 after Q₁ is turned off. The turn off of Q₁ correlates with the fall of the Q₁ V_{gs} waveform. The waveforms were measured with a 48Vdc input voltage, and 5-A resistive load.

Figure 2

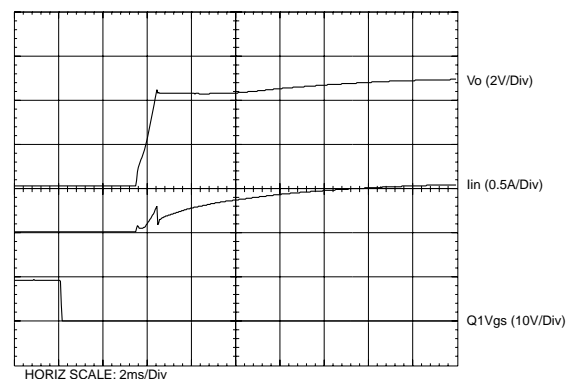

VDE Approved Installation Instructions (Installationsanleitung)

Nennspannung (Rated Voltage):	PT3320 36 to 72 Vdc, Transient to 75Vdc	
	PT3340 18 to 60 Vdc	
Nennaufnahme (Rated Input):	PT3320 1.5 Adc	
	PT3340 3.0 Adc	
Nennleistung (Rated Power):	30 Watts Maximum	
Ausgangsspannung (Sec. Voltage):	PT3320 Series	PT3340 Series
	PT3321, 3.3 Vdc, 8.0 Adc	PT3341, 3.3 Vdc, 8.0 Adc
	PT3322, 5.0 Vdc, 6.0 Adc	PT3342, 5.0 Vdc, 6.0 Adc
Ausgangsstrom (Sec. Current):	PT3323, 12.0 Vdc, 2.5 Adc	PT3343, 12.0 Vdc, 2.5 Adc
oder (or)	PT3324, 15.0 Vdc, 2.0 Adc	PT3344, 15.0 Vdc, 2.0 Adc
Ausgangsleistung (Sec. Power):	PT3325, 2.0 Vdc, 8.0 Adc	
	PT3326, 2.5 Vdc, 8.0 Adc	
	PT3327, 1.8 Vdc, 8.0 Adc	
	PT3328, 5.2 Vdc, 6.0 Adc	
	PT3329, 6.0 Vdc, 5.0 Adc	
	PT3330, 8.0 Vdc, 3.75 Adc	
	PT3331, 9.0 Vdc, 3.3 Adc	

Angabe der Umgebungstemperatur

(Information on ambient temperature): +85°C Ambient or 100°C Case Maximum

Besondere Hinweise (Special Instructions):

Es ist vorzusehen, daß die Spannungsversorgung in einer Endanwendung über eine isolierte Sekundärschaltung bereit gestellt wird. Die Eingangsspannung der Spannungsversorgungsmodule muss eine verstärkte Isolierung von der Wechselstromquelle aufweisen.

Die Spannungsversorgung muss gemaess den Gehaeuse-, Montage-, Kriech- und Luftstrecken-, Markierungs- und Trennanforderungen der Endanwendung installiert werden. Bei Einsatz eines TNV-3-Einganges muss die SELV-Schaltung ordnungsgemaess geerdet werden.

(The power supply is intended to be supplied by isolated secondary circuitry in an end use application. The input power to these power supplies shall have reinforced insulation from the AC mains.)

The power supply shall be installed in compliance with the enclosure, mounting, creepage, clearance, casualty, markings, and segregation requirements of the end-use application. When the input is TNV-3, the SELV circuitry must be reliably grounded.)

Offenbach,

VDE Prüf- und Zertifizierungsinstitut
Abteilung / Department TD

(Jürgen Bärwinkel)

Ort / Place:

Datum / Date:

K. Yena 12/12/01

(Stempel und Unterschrift des Herstellers / Stamp and signature of the manufacturer)

IMPORTANT NOTICE

Texas Instruments Incorporated and its subsidiaries (TI) reserve the right to make corrections, modifications, enhancements, improvements, and other changes to its products and services at any time and to discontinue any product or service without notice. Customers should obtain the latest relevant information before placing orders and should verify that such information is current and complete. All products are sold subject to TI's terms and conditions of sale supplied at the time of order acknowledgment.

TI warrants performance of its hardware products to the specifications applicable at the time of sale in accordance with TI's standard warranty. Testing and other quality control techniques are used to the extent TI deems necessary to support this warranty. Except where mandated by government requirements, testing of all parameters of each product is not necessarily performed.

TI assumes no liability for applications assistance or customer product design. Customers are responsible for their products and applications using TI components. To minimize the risks associated with customer products and applications, customers should provide adequate design and operating safeguards.

TI does not warrant or represent that any license, either express or implied, is granted under any TI patent right, copyright, mask work right, or other TI intellectual property right relating to any combination, machine, or process in which TI products or services are used. Information published by TI regarding third-party products or services does not constitute a license from TI to use such products or services or a warranty or endorsement thereof. Use of such information may require a license from a third party under the patents or other intellectual property of the third party, or a license from TI under the patents or other intellectual property of TI.

Reproduction of information in TI data books or data sheets is permissible only if reproduction is without alteration and is accompanied by all associated warranties, conditions, limitations, and notices. Reproduction of this information with alteration is an unfair and deceptive business practice. TI is not responsible or liable for such altered documentation.

Resale of TI products or services with statements different from or beyond the parameters stated by TI for that product or service voids all express and any implied warranties for the associated TI product or service and is an unfair and deceptive business practice. TI is not responsible or liable for any such statements.

Mailing Address:

Texas Instruments
Post Office Box 655303
Dallas, Texas 75265